

Wireless Temperature Sensor YL-104 Version: V1.0



Catalogue

1、 Product Overview	3
2、 Sensor Specifications	4
3、 Dimemision of the Tag.	5
4、 Structure of the sensor and installation method.....	5
5、 Parameter configuration.....	6
6、 Display the sensor data by SSCOM.....	8
7、 Communication Protocol.	10

1、 Product Overview

Adopt high-performance low-power single-chip ASR6601, taking into account sensor data acquisition and wireless data transmission.

Built-in low-power high-precision digital temperature and humidity sensor chip, measurement and accuracy range:

Temperature: $\pm 1\text{ }^{\circ}\text{C}$ (max) @-10 to 85 $^{\circ}\text{C}$, -40 to +125 $^{\circ}\text{C}$

Wireless data transmission uses LoRa and NB-IoT solutions:

LoRa solution (YL-104): Based on Semtech's low-power long-distance LoRa spread spectrum wireless data transmission scheme Sx1262, it has a sleep wireless wake-up function with a signal coverage of 2km.

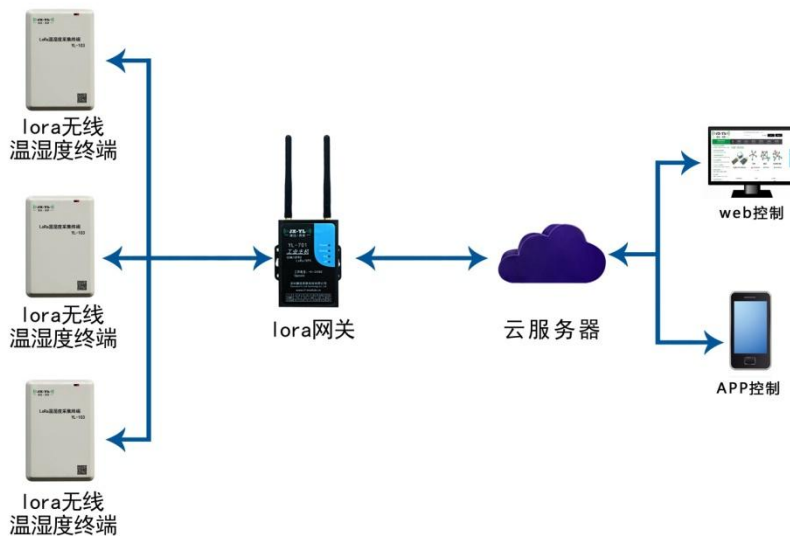

Built-in 2300mAH rechargeable lithium battery, long battery life, reusable.

The card type is ultra-thin design, small in size and easy to install.

It is widely used in communication equipment room, workshop production line, drug warehouse, large-scale logistics warehouse, agricultural greenhouse, greenhouse flower greenhouse, archives, museum, HVAC control and other IoT application scenarios that require temperature and humidity monitoring and alarming.

2、Sensor Specifications

Type of wireless	LoRa solution	NB-IoT solution
Frequency	433MHz、868MHz, 915MHz	All bands
Range	2 km line of sight	NB-IoT network coverage
Power	Built-in2300mAh rechargeable lithium battery (high and low temperature battery is optional)	
Port	Magnetic socket	
Temperature measurement	-20~80 ℃ (conventional lithium battery), -40~80 ℃ (low temperature lithium battery), -40~85 degrees (lithium battery), ±1 ℃;	
Sleep power consumption	10uA	
Parameter configuration	UART-TTL (Mini-USB connector form) with magnetic socket.	
Sample period	Timing report, the minimum can be set for 1 minute, the longest is 60 minutes, if not set, it will not be reported.	
Alarm threshold	The temperature alarm value can be set. When an alarm occurs, it will be reported three times within 1 minute; if it is not set, it will not be reported.	
size and weight	104.5*69.5*11.3mm, 85g (with lithium battery)	

3、 Dimension of YL-104.

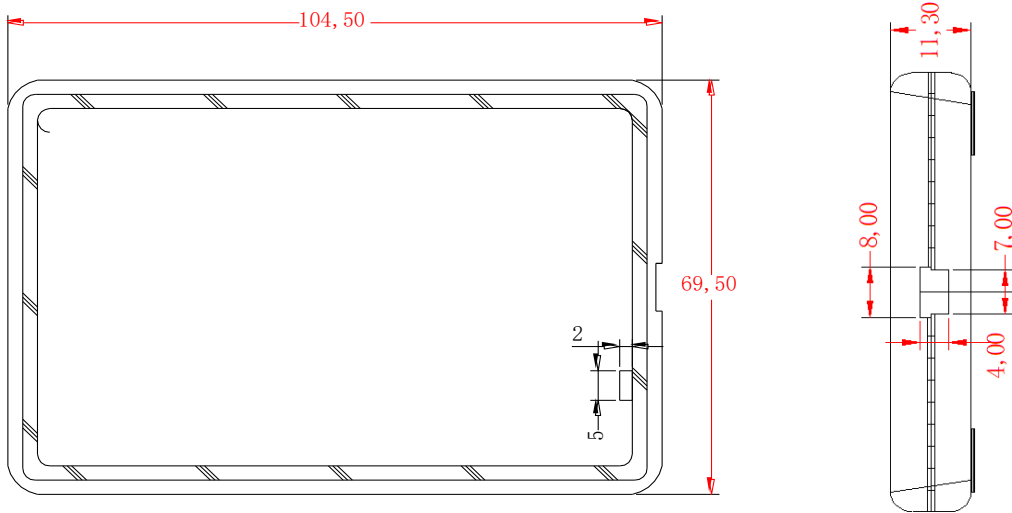

4、 Structure of the sensor and installation method

When installing the sensor, try to make the antenna perpendicular to the horizontal plane, and the wireless communication is the best.

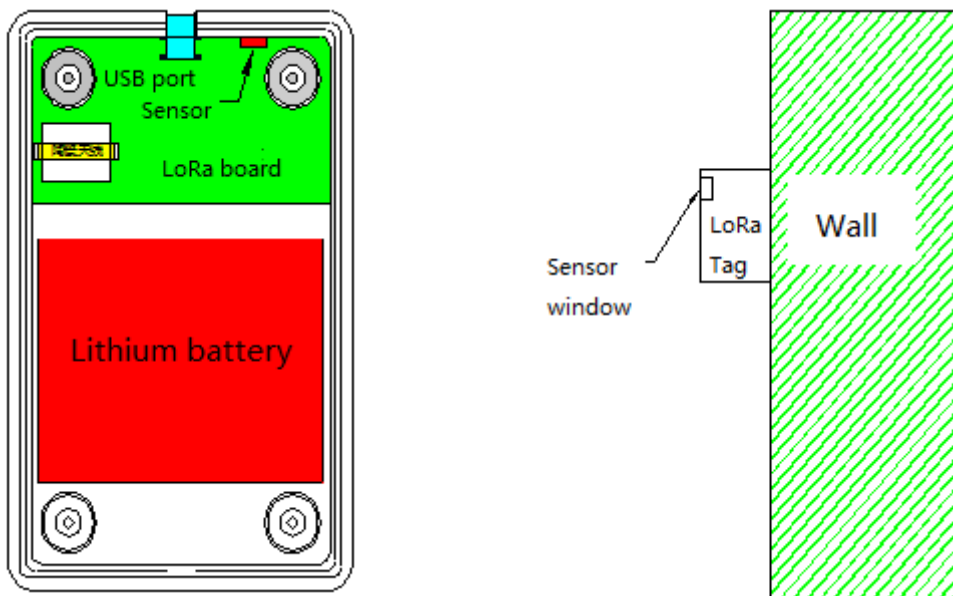

5、Parameter configuration

The company provides parameter setting software for this sensor (LoRa version), wireless parameters such as frequency, period, node ID, network ID, and transmission power.

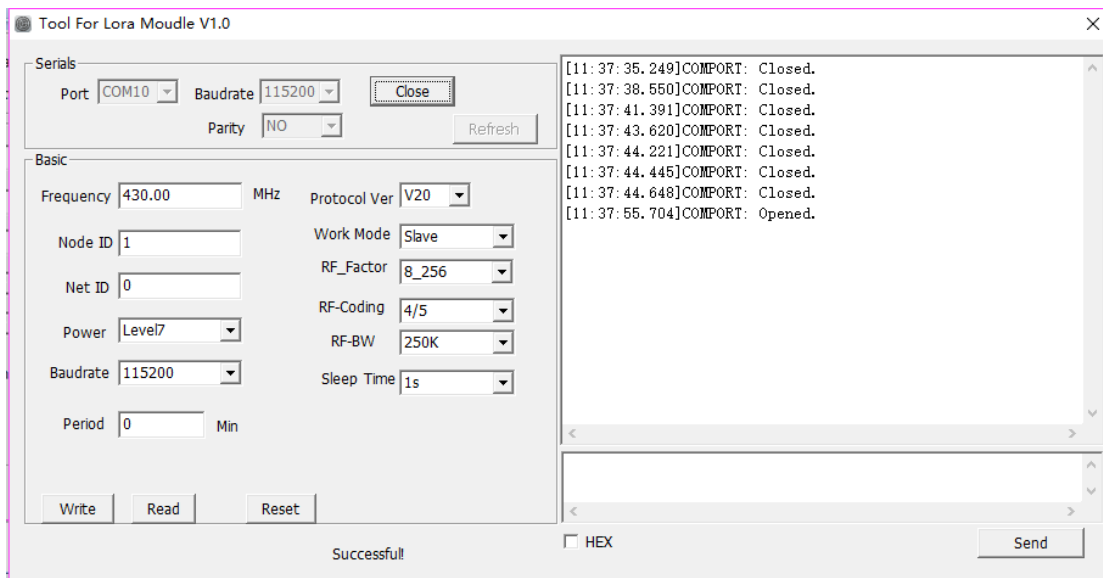

After connecting the sensor to the computer through the USB-TTL data cable (mini-USB connector), the sensor is in the setting state, open the “Tool for LoRa module V1.0”, click “com”, select the com port number The COM port, with a baud rate of 115200, No parity. The default baurate of YL-104 is 115200bps, No parity.

Wireless Temperature Sensor YL-104

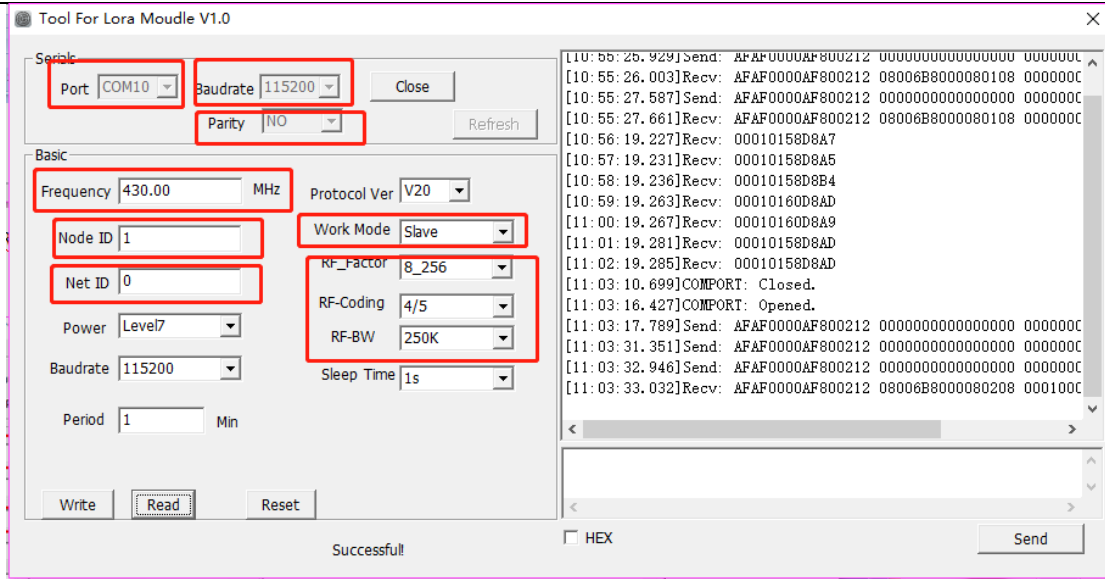

In the 'basic config', There are Frequency, Period, Net ID, Node ID, Work Mode, RF-Factor, RF-Coding, RF-BW and power are necessary for the debug.

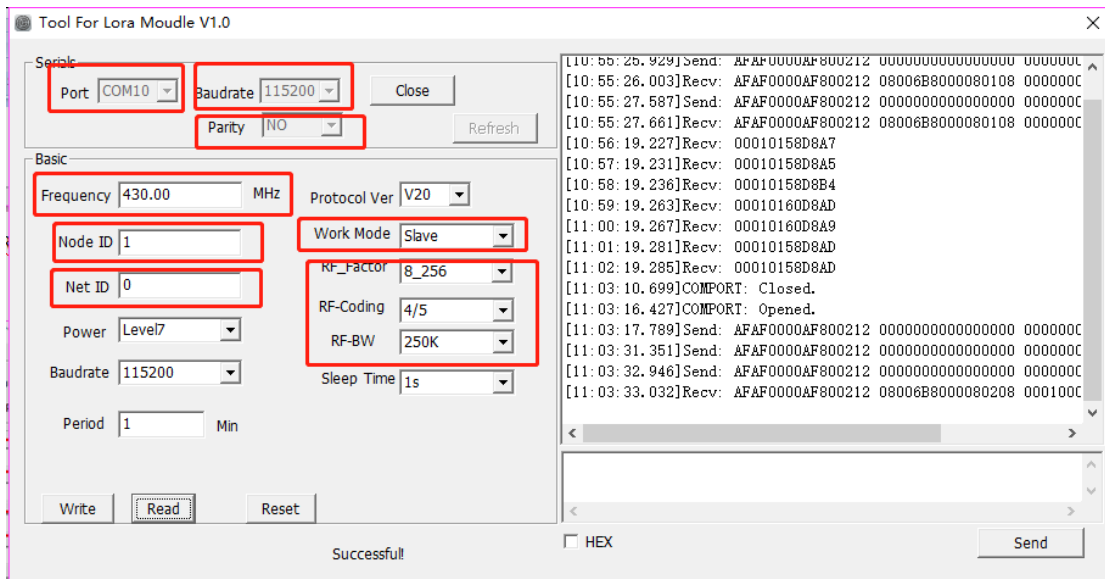

Parameter	Description							
Frequency	433MHz, 868MHz, 915MHz							
Protocol Ver	V10, V20							
Node ID	0-255							
Net ID	0-255							
Output power	Level	7	6	5	4	3	2	1
	dBm	19.5-20	17.5-18	14.5-15.5	11.5-12.5	8.5-9.5	5.5-6.5	5.5-6.5
	mA	110-120	90-100	60-70	45-55	40-45	30-40	30-40
Period	0-60mins, set'0'means the YL-104 is closed.							
Work Mode	Transparent, Central, Slave							
RF-Factor	5_32, 6_64, 7_128, 8_256, 9_512, 10_1024, 11_2048, 12_4096							
RF-Coding	4/5, 4/6, 4/7, 4/8							
RF-BW	62.5K, 125K, 250K, 500K							
Write	Write the parameter.							
Read	Read the parameter.							
Enter Update	Enter the upgrade mode							
FoTa	Enter the Fota upgrade the YL-104							
Data Display	Read the temperature data of YL-104 or display the data by serials							

After the sensor parameters are configured, disconnect the data line to put the sensor into operation.

6、Display the sensor data by SSCOM

The company provides the RF6610T LoRa data transmission module. **Users need to set the RF6610T as Central mode, The Breath of YL-104 should be the same as the net ID, RF-Factor, RF-Coding, RF-BW of RF6610T. The Frequency and the Net ID should be the same for both YL-104 and RF6610T.** After the configuration finish, RF6610T can be used as the host computer module to communicate with the sensor and display the sensor data via SSCOM. After finish the configuration, please close the serial port of RF tool.

Wireless Temperature Sensor YL-104

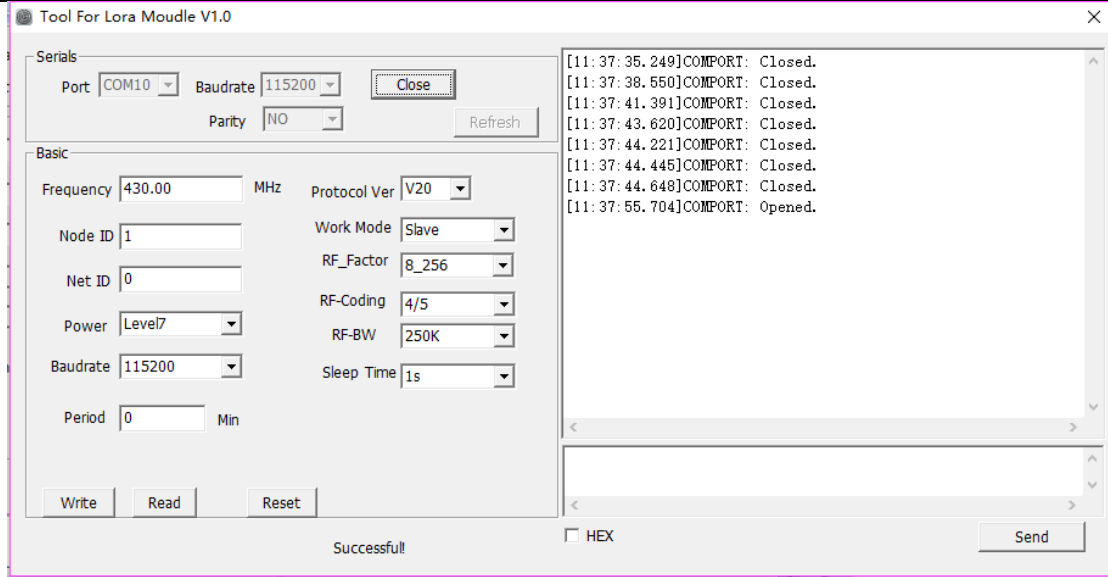

Users configure Frequency, Net ID, work mode, RF_Factor, RF_Coding and RF_BW for RF6610T. RF mode should be 'Central' mode. **The frequency, Net ID, RF_Factor, RF_Coding and RF_BW should be same for both RF6610T and YL-103.** Otherwise YL-103 and RF6610T will not communicate with each other.

Appconwireless provides USB adapter cable, which can connect the TTL host computer module to the computer USB interface for data acquisition. The sensor data can display by SSCOM

The computer module has dedicated parameter configuration software, and the wireless parameters (Frequency, Breath time, Net ID) need to be set to be consistent with YL-104.

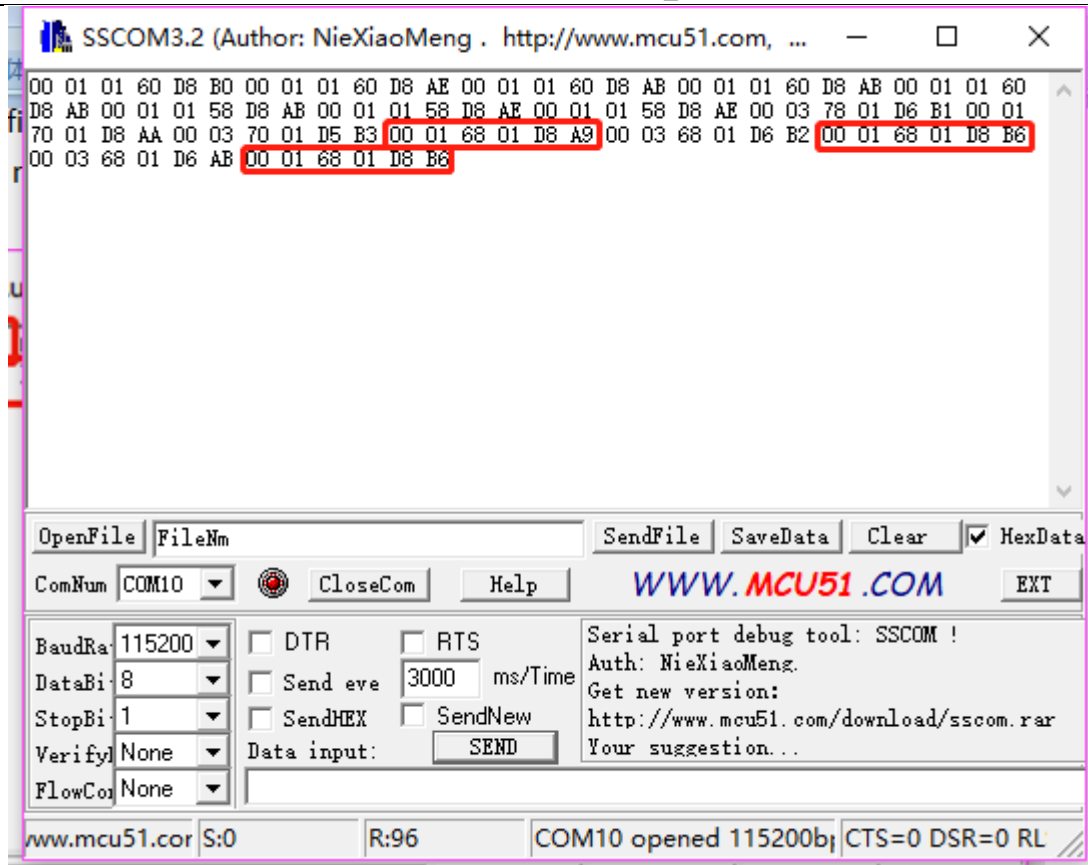

7、Communication Protocol.

The transmitted data format of YL-103: ID (Net ID(1byte)+ Node ID(1byte)) + 18b20 sensor Data(LSB+MSB) (2byte) + Bat(1byte)

The output data format of RF6610T: ID (Net ID(1byte)+ Node ID(1byte)) + 18b20 sensor Data(LSB+MSB)(2bytes) + Bat(1byte) + RSSI(1byte)

When the RSSI value is lower than 7E, the signal is weak.

APPCON WIRELESS TECHNOLOGY
CO.,LTD

Add: 28#, Longjin road,Xili zone, Nanshan
District Shenzhen P.R.C(518043)

TEL: +86-185 0309 2598

FAX: +86-755-83405160

Email: sales@appconwireless.com

Web: <http://www.appconwireless.com>

AppconWireless technology reserves the right to make corrections, modifications, improvements and other changes to its products and services at any time and to discontinue any product or service without notice. Customers are expected to visit websites for getting newest product information before placing orders.

These products are not designed for use in life support appliances, devices or other products where malfunction of these products might result in personal injury. Customers using these products in such applications do so at their own risk and agree to fully indemnify AppconWireless technology for any damages resulting from improper use