

1. General

RF4432PRO series is a long range, low power, high performance transparent bi-direction semi-duplex GFSK transceiver with operation at 433/470/868/915 Mhz. It integrates with high speed MCU from ST and high performance RF IC Si4432. Adopting high efficiency forward error correction with interleaving encoding (FEC) technology, it makes anti-interference ability and reception sensitivity greatly improved. That guarantees good performance in the harsh environment such as some industrial application. The FEC technique is advanced and unique in radio data communication field.

RF4432PRO has the UART/RS232/RS485 interface, that make it is easy to implement wireless data transmission. It is flexible for users to set the baud rate, frequency, output power, air data rate etc parameters. It can transmit transparent data with large data buffer and also can provide over 100 channels. The compact size makes it an ideal option for radio data communication application.

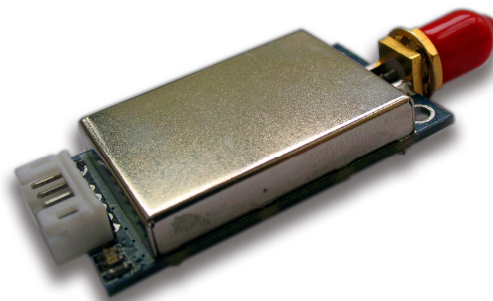

2. Features

- 1500 meters of communication distance (9600bps)
- Output power: Max100mW (20dBm) (127 levels adjustable)
- Air data rate: 1200 - 19200bps, can be configured through RF tool
- UART data rate: 1200 - 57600bps, can be configured through RF tool
- Frequency: 430MHz – 439.9MHz, 868MHz or 915MHz
- Working Current: 120mA(TX), 25mA(RX), 10.0uA(Sleeping)
- More than 8 channels
- parity of series COM: 8E1/8N1/8O1
- Receive sensitivity: -121dBm
- GFSK modulation
- UART/TTL, RS485, RS232
- Exceed 256 bytes data buffer
- Supply Voltage: 4.5 – 6.5V (the ripple less than $\pm 100\text{mV}$)
- Simply tool for configuration
- 250KHz Channel spacing
- Dimension: 39.0mm x 22.9mm x 7.0mm

3. Application:

- Automated Meter Reading (AMR)
- Remote control, remote measurement system
- Access control
- Access control
- Data collection
- Identification system
- IT household appliance
- Baby monitoring system

4. Maximum specification

Symbol	Parameter	Min	Max	Units
VCC	Supply Voltage	4.5	6.5	V
TOT	Operation Temperature	-30	85	°C
HOH	Operation Humidity	10%	90%	
TST	Storage Temperature	-55	125	°C

5. Pin Out:

RF4432PRO module has 5 pins. Refers to the Table 1 :

RF4432PRO		
Pin NO.	Pin Name	Description
1	VCC	Power supply DC 4.5V-6.5V
2	GND	Grounding of Power Supply
3	RXD	Serial input, 485+/485A
4	TXD	Serial output, 485-/485B
5	SLE	Suspended enable When normal mode. Sleep pin ($\cong 0.5V$): work mode; $(\cong 2.0V)$ or suspended: sleep mode;

Table 1: Pin definition

6. Dimension

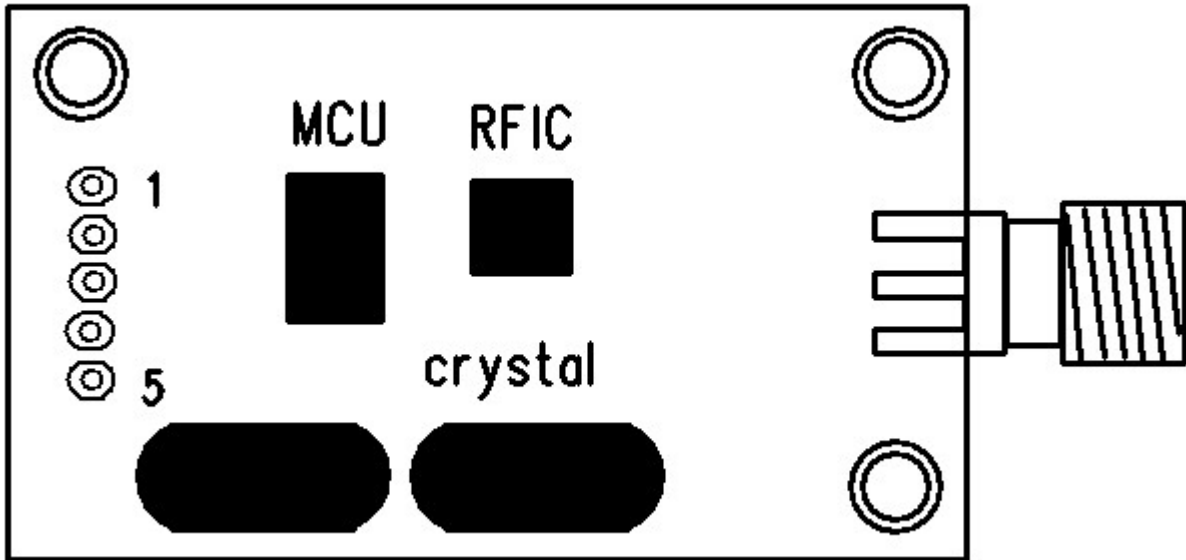

Figure 1: Size of Module

7. Parameter Configuration

Through serial port or using setting tool ‘Rf-Tool’, users can configure relative parameters such as frequency, UART rate, air rate, checkout mode and so on.

It is very simply for configuration. Based on different requirement, all options can be selected visually. It is shown in Table 2 and Figure 3.

The instruction of RF4432PRO parameters		
Setting	options	default

RF4432PRO UART Tranceiver module V2.0

MCU data rate	1200,2400,4800,9600,19200,38400,57600,115200bps	9600bps
Series Parity Check	N, 8, 1	N
Frequency	430MHz-439MHz	433 MHz
	860 MHz-868MHz	868MHz
	900MHz-919.9MHz	915MHz
GFSK data rate	1200,2400,4800,9600,19200,38400,57600bps	9600bps
Output Power	0-127levels(level 127 is 500mW)	127(500mW)
Series baud rate	1200,2400,4800,9600,19200,38400, 57600,115200bps	9600

Table 2: Parameter Specification

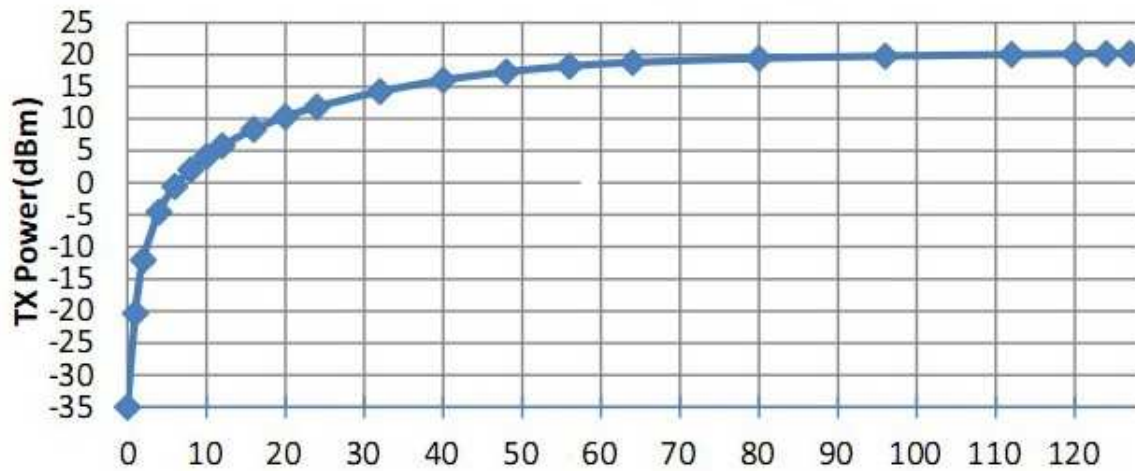

Figure 2: Indication of TX power level

RF4432PRO UART Transceiver module V2.0

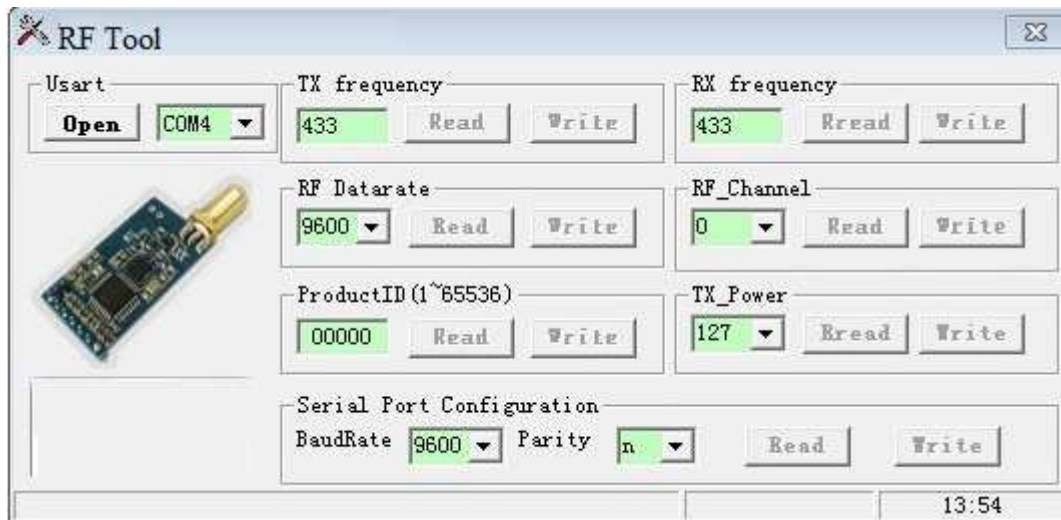

Figure 3: Interface of RF Tool

Users can configure the parameters (frequency, data rate, output power etc.) through PC or in circuit.

◆ Setting through PC. RF4432PRO port is UART/TTL. When RF4432PRO connecting with PC, users need to use USB adapter. AppconWireless provides USB adapter as accessory. The schematic is shown in Figure 4

Firstly users connect converter board to PC through DB9 cable and open 'RF Tool', then insert module into converter board. After that, the status column of 'RF tool' will give a indication 'Found Device'. Users then can read/write the module.

If users connect USB converter, USB drive "PL-2303_Driver_Installer" need be installed firstly. The drive has different version for different OS. USB converter has five wires with five different colors: Black, Red, Blue, Yellow, Green. Black wire is GND pin. Red wire is VCC pin. Blue wire is TXD pin.

RF4432PRO UART Tranceiver module V2.0

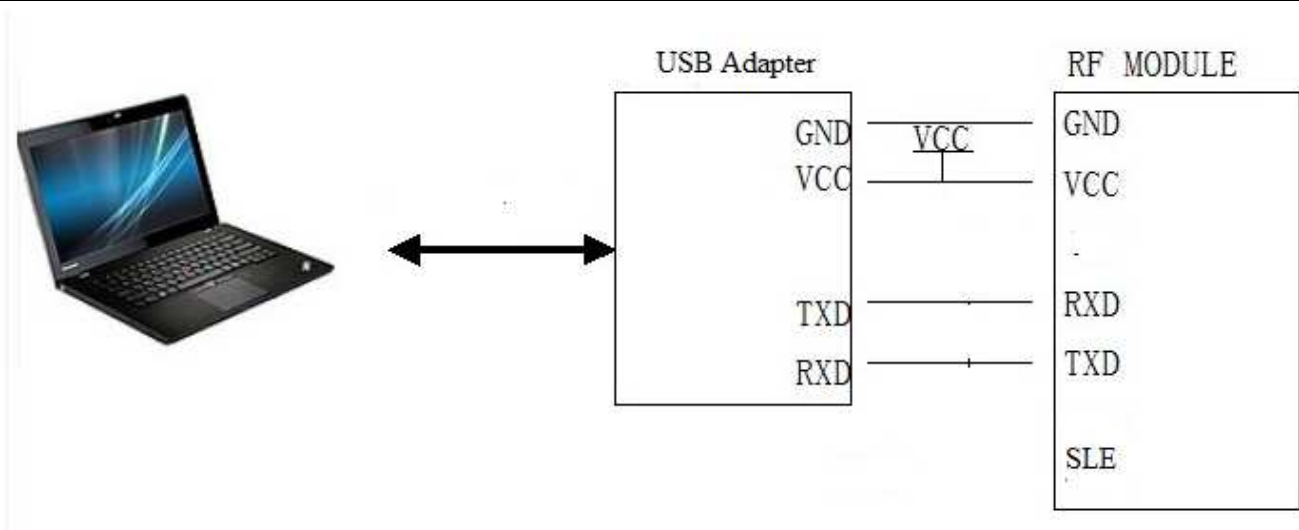

Figure 4: The connection diagram

◆ Setting in circuit . The module can work normally after powering on for 50ms (T1) or more. When configuring the module, users need to switch the module to sleep mode (EN pin is high or suspended) and monitor AUX pin. When AUX pin is high (no Receive or Transmit), the module will enter sleep mode in which the module can be configured after 20us (T2). When command is input to RXD pin, the module will be evoked. No matter what status of UART interface, the module will use 9600bps (data rate) and no parity check as default format to communicate.

When a command is sent to the module through the RXD pin, the module will send back response information by TXD pin in 50ms or less (T3) after it verifies the command is correct. The module then will be reset and initialized automatically and work with new settings after 100ms (T4). If the input command is incorrect, the module will make no response but it will still be reset and initialized. Users can take this advantage to wake up modules in long-term sleep or reset the modules.

RF4432PRO UART Tranceiver module V2.0

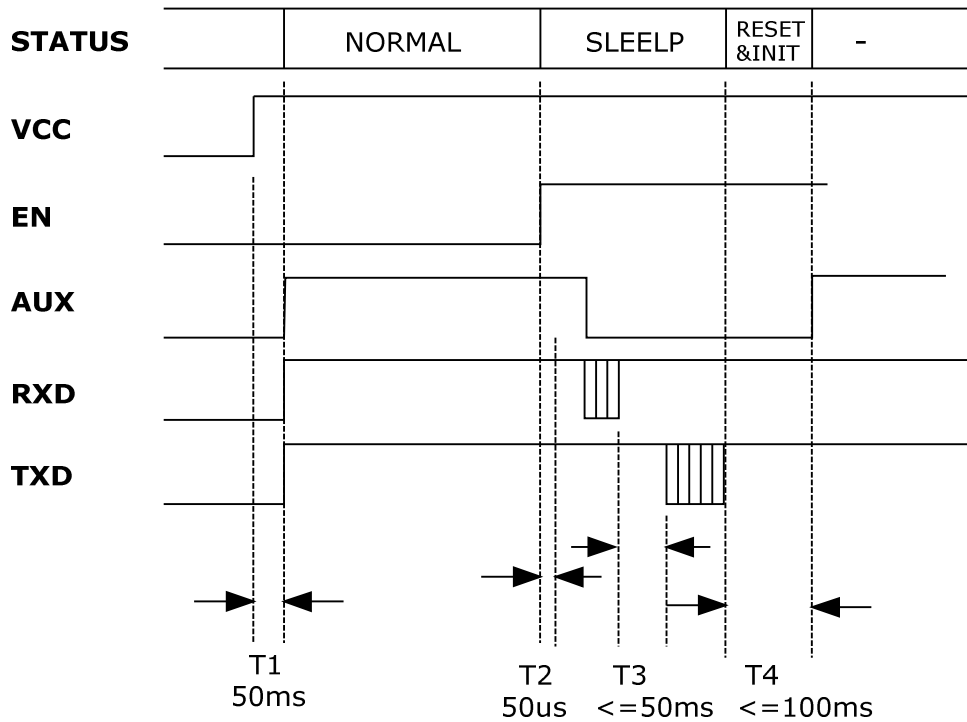

Figure 6: Timing diagram for Setting Parameters

The commands of RF4432PRO are in ASCII format. The default configuring data rate is 9600bps and no parity check is adopted. The command set include two commands: Read command and Write command.

◆ Read command: RD ✓

Acknowledge (from module): PARA_Freq_DR_{FSK}_P_{OUT}_DR_{IN}_Parity ✓

◆ Write command: WR_Freq_DR_{FSK}_P_{OUT}_DR_{IN}_Parity ✓

Acknowledge (from module): PARA_Freq_DR_{FSK}_P_{OUT}_DR_{IN}_Parity ✓

('_' means one blank space)

RF4432PRO UART Tranceiver module V2.0

Parameter	Unit	Length(Byte)	Description
Freq.	KHz	6	434MHz = 434000
DR _{FSK}	K bps	1	2400,4800,9600,19200 bps equal to 1,2,3,4
Pout	dB	1	0~9; 0 refers to 0dBm and 9 for 27dBm
DR _{IN}	Kbps	1	1.2, 2.4, 4.8, 9.6, 19.2, 38.4, 57.6 equals to 0,1,2,3,4,5,6
Parity		1	0: No parity; 1: Even parity; 2: Odd parity

Table 3: RF4432PRO Parameter Coding

E.g. If the user wants to set the module work at Freq (434MHz), DR_{IN} (1.2K bps), P_{OUT} (20dBm), DR_{FSK} (9.6k bps) and Parity (no parity), the command could be written as below:

Write Command: `WR_434000_3_9_0_0`

Corresponding HEX code: `0x57,0x52,0x20,0x34,0x33,0x34,0x30,0x30,0x30,0x20,0x33,0x20,0x39,0x20,0x30,0x20,0x30,0x0D,0x0A`

Acknowledge: `PAPA_434000_3_9_0_0`

Corresponding HEX code: `0x50,0x41,0x52,0x41,0x20,0x34,0x33,0x34,0x30,0x30,0x30,0x20,0x33,0x20,0x39,0x20,0x30,0x20,0x30,0x0D,0x0A`

8. Application Schematic:

The connection schematic between RF4432PRO and MCU or terminal is shown as below. If users do not need wake-up mode, SLE pin could be suspended. If users need wake-up mode in order to save power in the application, there are three types of wake-up mode: a, hardware wake-up mode. b, serial port wake-up mode. c, preamble wake-up mode. These three modes can be configured from RF TOOL.

a. Hardware wake-up mode: When modules enter hardware wake-up mode, the modules is in deep sleep as the consumption current is less than 10uA. If users need RF4432PRO in Receive or Transmit status,

RF4432PRO UART Tranceiver module V2.0

the SLE pin should be input low voltage. The modules will be ready within 10ms. So we recommend input data to modules after 60ms. Hardware wake-up mode is the default setting of RF4432PRO. The time diagram about this progress is shown in Figure 7.

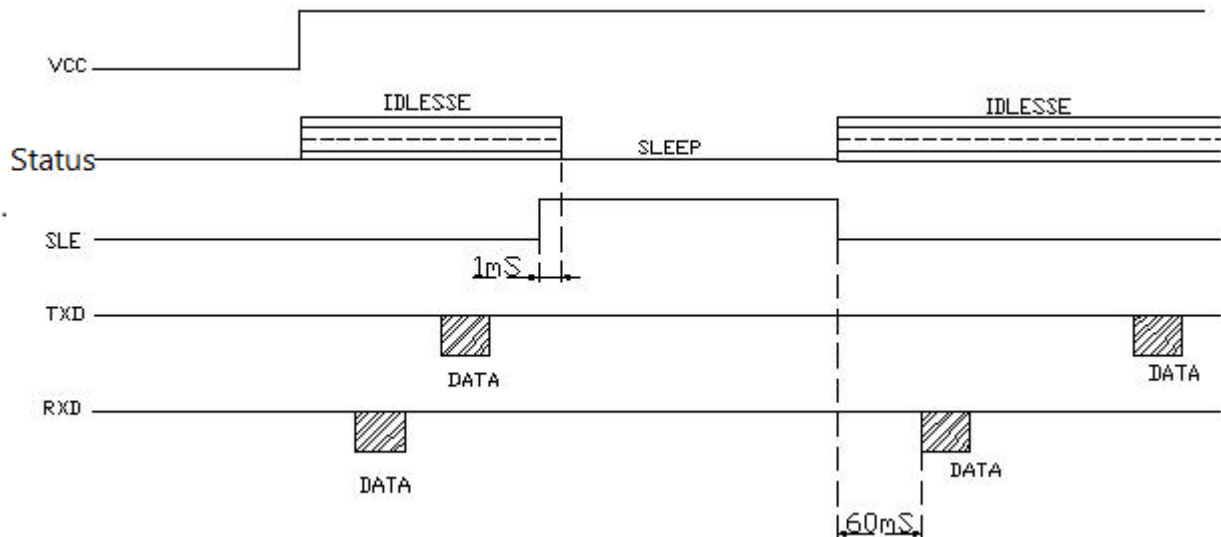
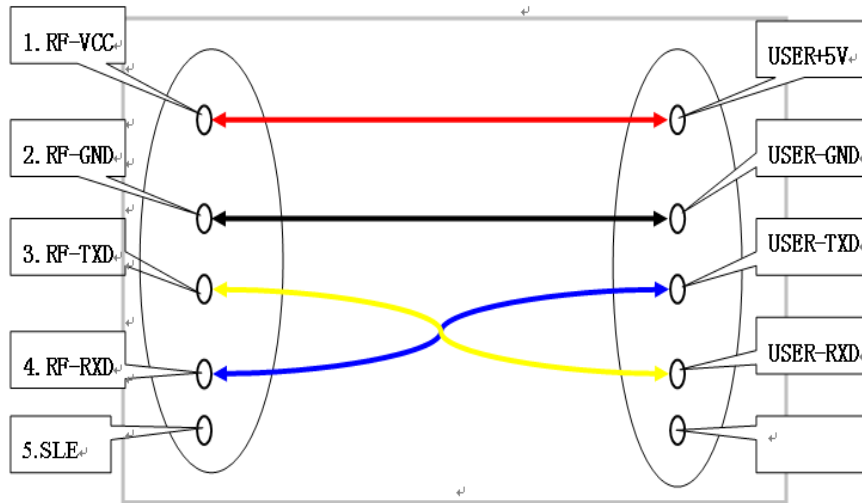

Figure 7. Time diagram of hardware wake-up mode

- b. Serial wake-up mode: When modules enter Serial Wake-up mode, the consumption current is about 11mA. Users just need send some **format data (such as)** to wake up RF4432PRO. RF4432PRO will be in Receive or Transmit status within 10ms. If any data don't exist the memory of RF4432PRO, the modules will get into serial wake-up mode again. If any data that don't exist the memory of RF4432PRO beyond 20S , the modules will get into serial wake-up mode again
- c. Preamble wake-up mode: The power consumption of RF4432PRO is less than 20mA in this mode. The modules are in the polling mode to listen the signal from master transmitter. When modules receive wake-up data from master transmitter, RF4432PRO will be in RX status within 10ms. If modules don't receive any data from the air beyond 20S, the modules will get into preamble wake-up mode again

The parameter of RF4432PRO's serial port must match with MCU or terminal's (RF4432PRO has the same serial port baud rate and parity style with MCU or terminal). Two or more RF4432PROs in a system should have the same parameters such as TX/RX frequency, air date rate and RF channel.

RF4432PRO UART Tranceiver module V2.0



- Caution:**
1. When RF4432PRO is installed, make sure the antenna is far away from device to enhance the performance.
 2. RF4432PRO should have the same common ground with MCU or terminal. Otherwise it may cause the module irregular working.
 3. When RF4432PRO works normal, DO NOT touch the module and antenna.

Figure 7: Connection between Module and Device(TTL/RS232 port)

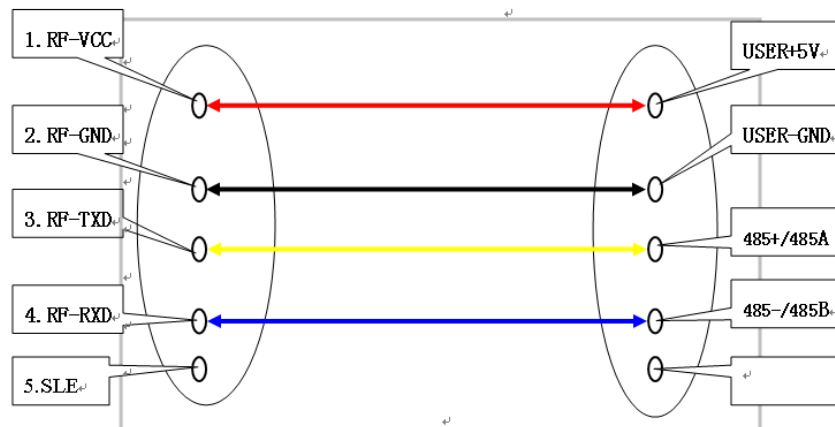

Figure 8: Connection between Module and Device(RS485 port)

Constructing Network (one point to multi-point):

RF4432PRO is a semi-duplex module, which can be communicated by point to point or one point to multi-point. In the second mode, user needs to set one master module, while the others are slave modules. Every module must only have one unique ID. The coordination of communication is controlled by the master module, which sends data or commands including ID information. All slave modules can receive

the data packets, and compare the ID with itself. If they are matched, the module will deal with the data packets. Otherwise, it will discard them. In order to avoid interfering each other, only one module can be in transmitting state when the network is working. RF4432PRO can set many different frequencies so that many networks can work in the same place and at the same time.

User should pay attention to the following questions based on the complex transfers in the air and some inherency characteristics of wireless communication:

1) Latency of wireless communication

The wireless terminal keeps receiving data packets after waiting for a while to ensure no data any more. There should be tens to hundreds mil-seconds latency from transfer to receiver (the exact latency depended on UART rate, air rate and the size of data package). In addition, it also need consume some time to transmit from module to terminal, but the delay time is permanent in the same condition.

2) Data flux control

Although there is a buffer zone with 256 bytes in the wireless module, when the UART rate is higher than the air rate, there must be a problem about the data flux. It may cause to lose some data because the data overflow from the buffer. Under this condition, it must be ensured that the average UART rate should NOT higher than 60 percent of the air rate. For instance, the UART rate is 9600bps, the air rate is 4800bps. If UART rate is the same as the air rate, the only way is to interval the transmitting time. If terminal transmits 100bytes to UART every time, it will take 104ms every time. $(104\text{ms}/0.6) \times (9600/4800) = 347\text{ms}$. So if the interval time that terminal transmit 100bytes to UART should NOT less than 347ms every time, those mentioned problems can be avoided.

3) Error control

The wireless network module has strong capability of anti-interference because of the high efficiency checking error correction with interleaving encoding technology. However, when it is in a bad circumstance that has strong electric interference, the data may be lost or receive some error data. User can increase the development of the system link layer protocol. For instance, if user can increase TCP/IP slip window and repeat transmitting functions, it will improve the reliability and ability of wireless network communication.

4) Selection of antenna

RF4432PRO UART Tranceiver module V2.0

Antenna is a very important factor of the communication system. The quality of antenna impacts the capability of communication system. So user should strictly choose the quality of antenna. Generally speaking, it mainly contains two points: the type of antenna (size) and its electric capability. The antenna must be matched with the frequency of communication system.

Q&A:

Questions and Answers	
Can not communicate between two devices	1. The communication protocol is different between two modules, for instance: data rate and checkout.
	2. The frequency or RF data rate is different between two communicated modules.
	3. They are not the same kind products.
	4. The connection between module and terminal is wrong.
	5. The module is wrong.
	6. The setting of EN is wrong.
	7. The communication distance exceeds the range, or the connection of antenna is bad.
Short communication distance	1. The supply voltage exceeds range
	2. The ripple of power is too big.
	3. The connection of antenna is bad or it is a wrong kind of antenna
	4. Antenna is too close to the surface of metal or the ground
	5. Receiving circumstance is very bad, for instance buildings and strong

RF4432PRO UART Transceiver module V2.0

	interference.
	6. There is interference of the same frequency
Receive wrong data	1. Wrong setting of COM, for example, Baud rate is wrong
	2. The connection of UART is wrong.
	3. The cable to the UART is too long.

<p>APPCON WIRELESS TECHNOLOGIES CO.,LTD</p> <p>Add: RMB1-B2,5F, 12Building,JinDiindustry zone, Futian District Shenzhen(518000)</p> <p>TEL: +86-755-83405199</p> <p>FAX: +86-755-83405160</p> <p>Email: sales@appconwireless.com</p> <p>Web: http://www.appconwireless.com</p>	<p>AppconWireless technologies reserves the right to make corrections, modifications, improvements and other changes to its products and services at any time and to discontinue any product or service without notice. Customers are expected to visit websites for getting newest product information before placing orders.</p> <p>These products are not designed for use in life support appliances, devices or other products where malfunction of these products might result in personal injury. Customers using these products in such applications do so at their own risk and agree to fully indemnify AppconWireless technologies for any damages resulting from improper use</p>
--	---