

## 1. General

RF1276D27 is a low cost, medium power, high performance transparent two way semi-duplex LoRa modulation transceiver with operation at 433/490Mhz. It integrates with high speed MCU from ST and high performance RF IC SX1276. Adopting high efficiency forward error correction with interleaving encoding (FEC) technology, it makes anti-interference ability and reception sensitivity greatly improved. That guarantees good performance in the harsh environment such as some industrial application. The FEC technique is advanced and unique in radio data communication field.

RF1276D27 has the UART/RS232/RS485 interface, that make it is easy to implement wireless data transmission. It is flexible for users to set the baud rate, frequency, output power, air data rate etc parameters. It can transmit transparent data with large data buffer and also can provide over 32 channels. The compact size makes it an ideal option for radio data communication application.



## 2. Features

- 10000 meters of communication distance (300bps)
- Output power: Max 500mW (27dBm) (7 levels adjustable)
- Air data rate: 300 - 19200bps, can be configured through RF tool
- UART data rate: 1200 - 57600bps, can be configured through RF tool
- Frequency: 410MHz - 460MHz, 460MHz – 510MHz
- Working Current: 450mA(TX), 24.2mA(RX), 1.2mA(idle), 220uA(Sleeping)
- More than 32 channels
- parity of series COM: 8E1/8N1/8O1
- LoRa modulation
- Receive sensitivity: -148dBm(@300bps)
- UART/TTL, RS232, RS485
- Exceed 256 bytes data buffer
- Supply Voltage: 4.5 – 15.0V (the ripple less than  $\pm 100\text{mV}$ )
- Simply tool for configuration
- 62.5KHz- 500KHz Channel spacing
- Dimension: 59.5mm x 39.6mm x 7.0mm

## 3. Application:

- Automated Meter Reading (AMR)
- Remote control, remote measurement system
- Access control
- Data collection
- Identification system
- IT household appliance
- Baby monitoring system

## 4. Maximum specification

Symbol	Parameter	Min	Max	Units
VCC	Supply Voltage	4.5	15.5	V
TOT	Operation Temperature	-30	85	°C
HOH	Operation Humidity	10%	90%	
TST	Storage Temperature	-55	125	°C

## 5. Pin Out:

RF1276D27 module has 5 pins. Refers to the Table 1:

RF1276D27		
Pin NO.	Pin Name	Description
1	VCC	Power supply DC 4.5V-15.5V
2	GND	Grounding of Power Supply
3	RXD	Serial input, 485+/485A
4	TXD	Serial output, 485-/485B
5	AUX	Data in/out indication

**Table 1: Pin definition**

## 6. Working mode

### a. Standard mode

Standard mode is also called transparent mode in which the module receives from or sends data to the host through serial port (RS232 or RS485) at preset data format and users don't need to care about the process of data inside the module. The AUX pin of RF1276D27 will give indication about the data IN/OUT of serial

port 2ms in advance in order to wake up the host.

发射模块时序图：

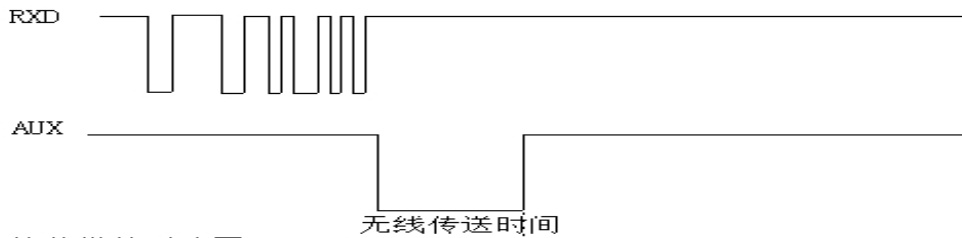

接收模块时序图：

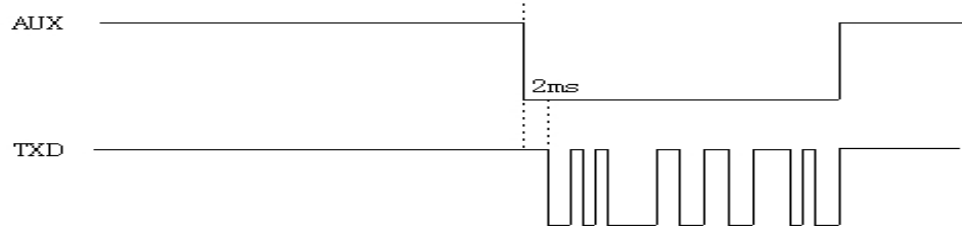

### Timing Sequence in Standard Mode

#### b. Low power mode

In this mode RF1276D27 enables serial port and CAD monitor which means the module monitors the wireless link periodically. When it detects the wireless signal in the wake-up period, it will open the receive circuit, pick out the effective data and transfer it to the host through the serial port. The AUX pin will produce a low level signal 2ms in advance to inform the host that the data comes.

发射模块时序图：



接收模块时序图：



### Timing Sequence in Low Power Mode

#### c. Sleep mode

In this mode most functions of the modules are disabled so if two modules are set to the Sleep Mode, they

# RF1276D27 500mW LoRa Transceiver module V2.0

can't communicate with each other so one module must be in Low Power Mode. Comparing to Low Power Mode, the modules in SLEEP MODE will not enable serial port and only keeps CAD monitor. When it detects effective wireless signal, it will then enable the serial port. If there is no data In/Out in 1 second, it will close the serial port and continue the CAD monitor

发射模块时序图：

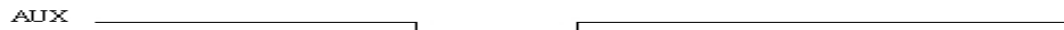

接收模块时序图：



无线传送时间加上间隙打开时间

2ms

Timing Sequence in Sleep Mode

## 7. Dimension

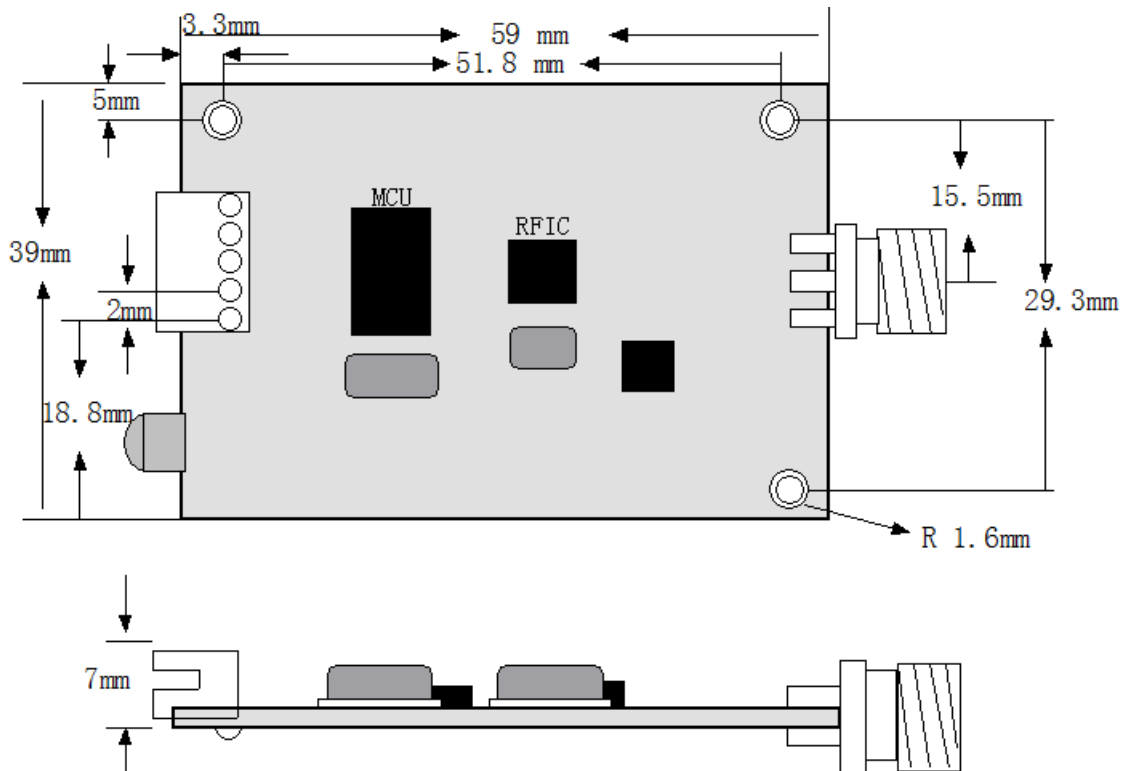

Figure 1: Size of Module

## 8. Parameter Configuration

Through serial port or using setting tool ‘Rf-Tool’, users can configure relative parameters such as frequency, UART rate, air rate, checkout mode and so on.

It is very simply for configuration. Based on different requirement, all options can be selected visually. It is shown in Table 2 and Figure 2.

Parameter	Description
UART area	The values are fixed at 9.6k bps & no parity check.
RF frequency	It indicates the center frequency of RF carrier
RF mode	Standard mode, Low Power mode
RF_Factor	Lora spreading factor. Larger value means higher sensitivity but longer air transmission time
RF_BW	Lora bandwidth. Larger value means lower sensitivity. Recommended value: 125K.
Node ID	Reserved
Net ID	Only the modules with the same network ID can communicate with each other. It can avoid interferences from irrelative modules
Power	It is used to set the output power of RF1276D27. There are 7 power levels. The 7 means the max output power---27dBm and 1 means the lowest output power.
Serial baudrate	It defines the data rate between RF1276D27 and the host
Serial parity	It defines the parity check between RF1276D27 and the host

**Table 2: Parameter Specification**

## RF1276D27 500mW LoRa Transceiver module V2.0

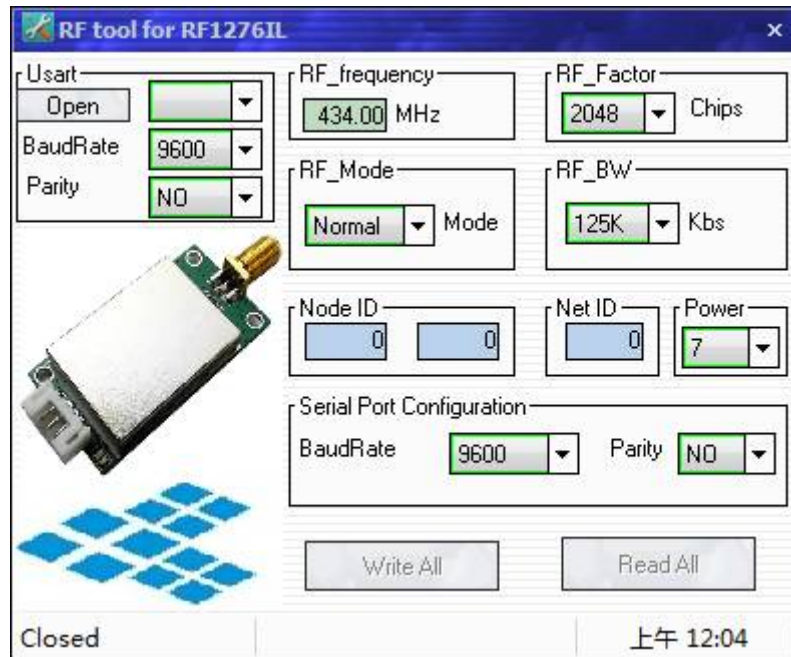

**Figure 2: Interface of RF Tool**

Users can configure the parameters (frequency, data rate, output power, RF Factor, RF Bandwidth etc.) through PC or in circuit.

◆ Setting through PC. RF1276D27 port is UART/TTL. When RF1276D27 connecting with PC, users need to use USB adapter. AppconWireless provides USB adapter as accessory. The schematic is shown in Figure 3

Firstly users connect converter board to PC through DB9 cable and open 'RF Tool', then insert module into converter board. After that, the status column of 'RF tool' will give a indication 'Found Device'. Users then can read/write the module.

If users connect USB converter, USB drive "PL-2303\_Driver\_Installer" need be installed firstly. The drive has different version for different OS. USB converter has five wires with five different colors: Black, Red, Blue, Yellow. Black wire is GND pin. Red wire is VCC pin. Blue wire is TXD pin.

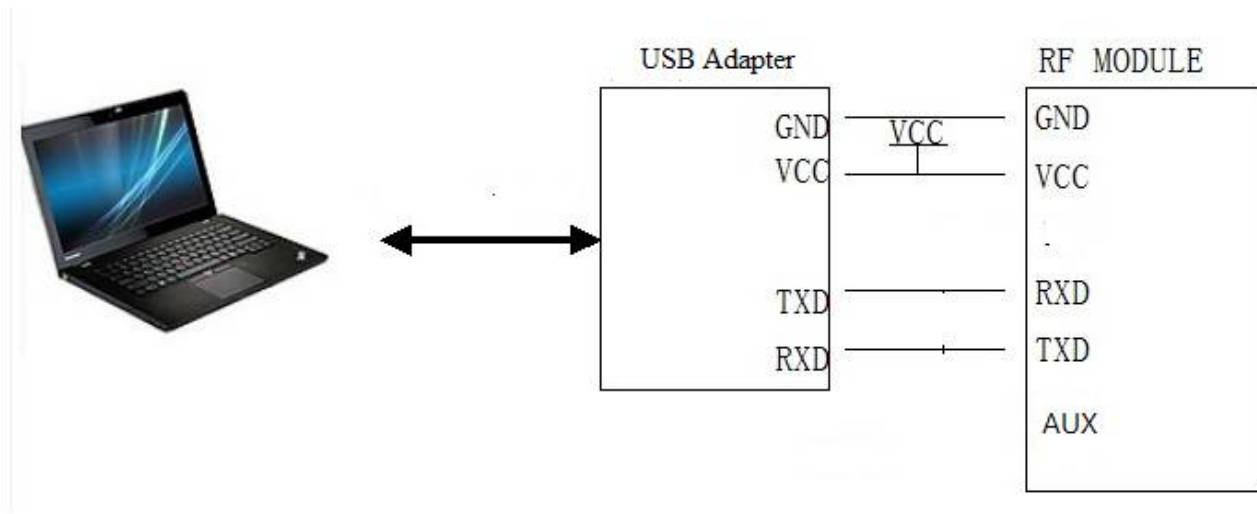

**Figure 3: The connection diagram**

◆ Setting in circuit . Users also can use microcontroller to change the default parameters. The work mechanism is the same as in PC.

Sync word		ID code		Header	Command		Length	Data	CRC	End code	
0xAF	0xAF	0x00	0x00	0xAF	XX	YY	LEN	XXXX	CS	0x0D	0x0A

RF1276D27 Command Structure

Notes: 1. The ID code is 0x00 0x00 in command.

2. In command code, XX in sending command is 0x80 and in response command is 0x00. YY is the command type. The work mode of

YY	TYPE	YY	TYPE	YY	TYPE	YY	TYPE	YY	TYPE
0x01	write	0x02	read	0x03	standard	0x04	Central	0x05	Node

**Command Type and Value**

3. Length refers to the data bytes between Length byte and CRC byte which the two bytes are not calculated in the length.

4. Data refers to the detailed parameters which need to be changed.



## RF1276D27 500mW LoRa Transceiver module V2.0

Baudrate	Parity	Frequency	RF_Factor	Mode	RF_BW	ID	NetID	Power
----------	--------	-----------	-----------	------	-------	----	-------	-------

### Parameter Sequence in Data Section

Parameters	Length	Values
Baudrate	1 byte	1=1200, 2=2400, 3=4800, 4=9600, 5=19200, 6=38400, 7=57600
Parity	1 byte	0=no parity check, 1=odd parity, 2=even parity
Frequency	3 bytes	The value=Frequency/61.035. E.g. For 433MHz, the value= 433000000/61.035
RF_Factor	1 byte	7=128, 8=256, 9=512, 10=1024, 11=2048, 12=4096
Mode	1 byte	0=standard, 1=low power, 2=sleep
RF_BW	1 byte	6=62.5k, 7=125k, 8=250k, 9=500k
ID	2 bytes	0x0000 ~ 0xFFFF, high byte first
NetID	1 byte	0x00~0xFF
RF_Power	1 byte	1=9dBm, 2=12dBm, 3=15dBm, 4=18dBm, 5=20dBm, 6=24dBm, 7=27dBm

### Parameter Length & Value Range

5. CS refers to CRC code which is the remainder of the sum of data section divided by 256 In order to understand the command, the section will demonstrate the use of commands by some examples.

Write Command Code: 0x01

Command: 0xAF, 0xAF, 0x00, 0x00, 0xAF, 0x80, 0x01, 0x0C, .... CS, 0x0D, 0x0A

Response.: 0xAF, 0xAF, 0x00, 0x00, 0xA F, 0x00, 0x01, 0x0C, .... CS, 0x0D, 0x0A

Read Command Code: 0x02

Command: 0xAF, 0xAF, 0x00, 0x00, 0xAF, 0x80, 0x02, 0x02, 0x00, 0x00, 0x91, 0x0D, 0x0A

Response.: 0xAF, 0xAF, 0x00, 0x00, 0xAF, 0x00, 0x02, 0x02, 0x00, 0x00, 0x91, 0x0D, 0x0A



## **RF1276D27 500mW LoRa Transceiver module V2.0**

---

Standard Mode Command Code: 0x03

Command: 0xAF, 0xAF, 0x00, 0x00, 0xAF, 0x80, 0x03, 0x02, 0x00, 0x00, 0x92, 0x0D, 0x0A

Response.: 0xAF, 0xAF, 0x00, 0x00, 0xAF, 0x00, 0x03, 0x02, 0x00, 0x00, 0x92, 0x0D, 0x0A

Central Mode Command Code: 0x04

Command: 0xAF, 0xAF, 0x00, 0x00, 0xAF, 0x80, 0x04, 0x02, 0x00, 0x00, 0x93, 0x0D, 0x0A

Response.: 0xAF, 0xAF, 0x00, 0x00, 0xAF, 0x00, 0x04, 0x02, 0x00, 0x00, 0x93, 0x0D, 0x0A

Node Mode Command Code: 0x05

Command: 0xAF, 0xAF, 0x00, 0x00, 0xAF, 0x80, 0x05, 0x02, 0x00, 0x00, 0x94, 0x0D, 0x0A

Response.: 0xAF, 0xAF, 0x00, 0x00, 0xAF, 0x00, 0x05, 0x02, 0x00, 0x00, 0x94, 0x0D, 0x0A

Please note that the working modes changed by the 0x03, 0x04 and 0x05 commands will not be written into nonvolatile memory so the working mode will be restored to the former mode before change after power-off. Users can use the WRITE command to change the working mode of module to standard mode or low power mode but the sleep mode will be restored to standard mode after next power-on even if the WRITE command is used.

### **9. Application Schematic:**

The connection schematic between RF1276D27 and MCU or terminal is shown as below.

The parameter of RF1276D27's serial port must match with MCU or terminal's (RF1276D27 has the same serial port baud rate and parity style with MCU or terminal). Two or more RF1276D27s in a system should have the same parameters such as TX/RX frequency, air data rate and RF channel.

## RF1276D27 500mW LoRa Transceiver module V2.0

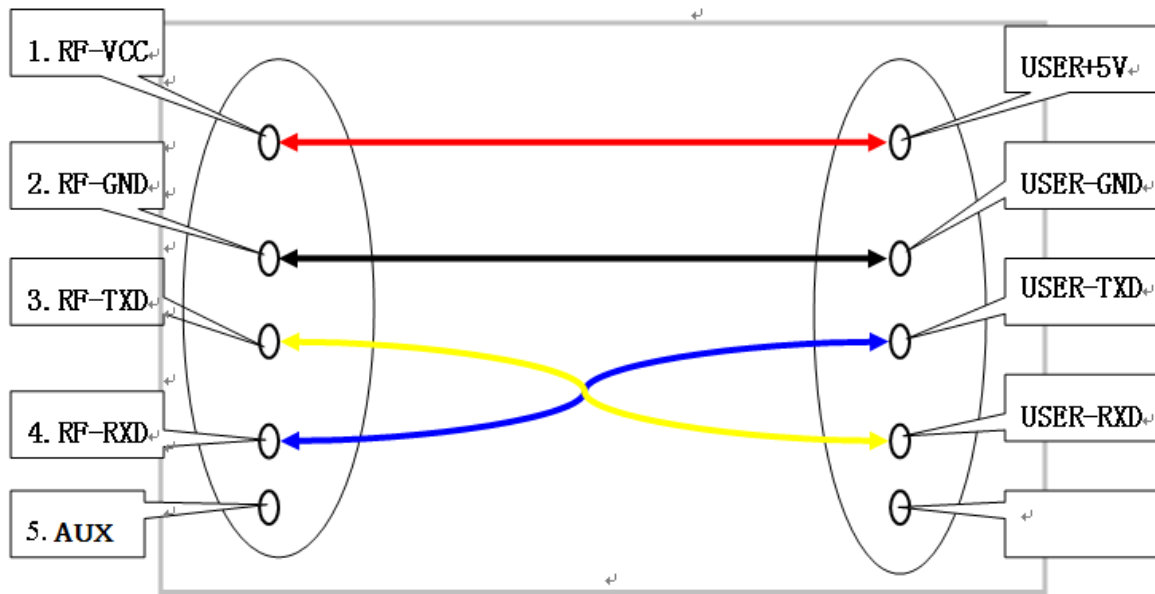

- Caution:**
1. When RF1276D27 is installed, make sure the antenna is far away from device to enhance the performance.
  2. RF1276D27 should have the same common ground with MCU or terminal. Otherwise it may cause the module irregular working.
  3. When RF1276D27 works normal, DO NOT touch the module and antenna.

**Figure 7: Connection between Module and Device(TTL/RS232 port)**

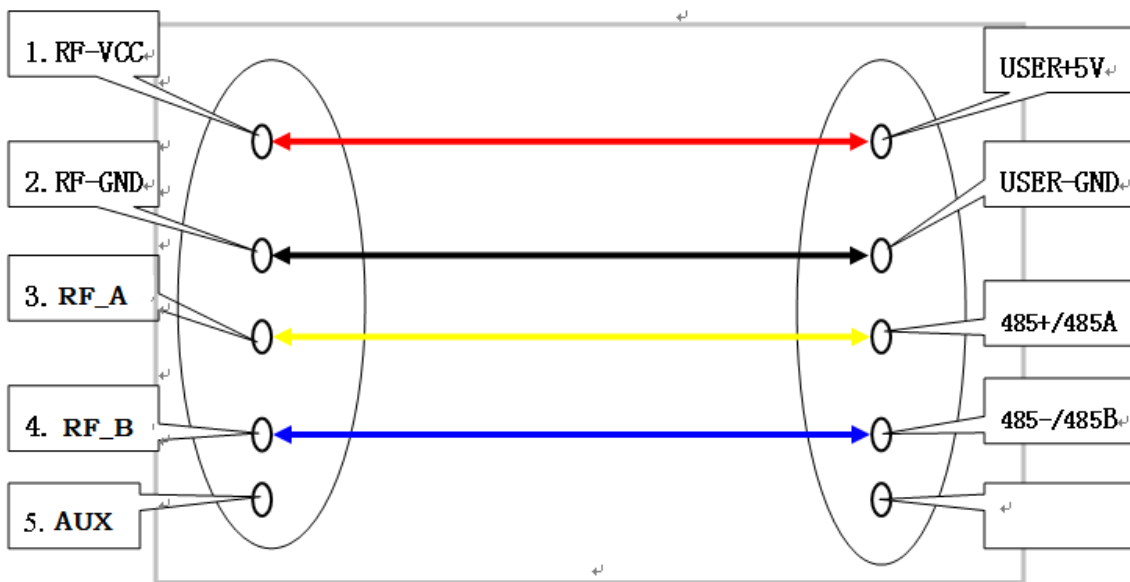

**Figure 8: Connection between Module and Device(RS485 port)**

### 10. Constructing Network (one point to multi-point):

RF1276D27 is a semi-duplex module, which can be communicated by point to point or one point to multi-point. In the second mode, user needs to set one master module, while the others are slave modules. Every module must only have one unique ID. The coordination of communication is controlled by the master module, which sends data or commands including ID information. All slave modules can receive the data packets, and compare the ID with itself. If they are matched, the module will deal with the data packets. Otherwise, it will discard them. In order to avoid interfering each other, only one module can be in transmitting state when the network is working. RF1276D27 can set many different frequencies so that many networks can work in the same place and at the same time.

User should pay attention to the following questions based on the complex transfers in the air and some inherency characteristics of wireless communication:

#### 1) Latency of wireless communication

The wireless terminal keeps receiving data packets after waiting for a while to ensure no data any more. There should be tens to hundreds mil-seconds latency from transfer to receiver (the exact latency depended on UART rate, air rate and the size of data package). In addition, it also need consume some time to transmit from module to terminal, but the delay time is permanent in the same condition.

#### 2) Data flux control

Although there is a buffer zone with 256 bytes in the wireless module, when the UART rate is higher than the air rate, there must be a problem about the data flux. It may cause to lose some data because the data overflow from the buffer. Under this condition, it must be ensured that the average UART rate should NOT higher than 60 percent of the air rate. For instance, the UART rate is 9600bps, the air rate is 4800bps. If UART rate is the same as the air rate, the only way is to interval the transmitting time. If terminal transmits 100bytes to UART every time, it will take 104ms every time.  $(104\text{ms}/0.6)*(9600/4800) = 347\text{ms}$ . So if the interval time that terminal transmit 100bytes to UART should NOT less than 347ms every time, those mentioned problems can be avoided.

#### 3) Error control

The wireless network module has strong capability of anti-interference because of the high efficiency

## RF1276D27 500mW LoRa Transceiver module V2.0

checking error correction with interleaving encoding technology. However, when it is in a bad circumstance that has strong electric interference, the data may be lost or receive some error data. User can increase the development of the system link layer protocol. For instance, if user can increase TCP/IP slip window and repeat transmitting functions, it will improve the reliability and ability of wireless network communication.

#### 4) Selection of antenna

Antenna is a very important factor of the communication system. The quality of antenna impacts the capability of communication system. So user should strictly choose the quality of antenna. Generally speaking, it mainly contains two points: the type of antenna (size) and its electric capability. The antenna must be matched with the frequency of communication system.

## 11. Q&A:

Questions and Answers	
Can not communicate between two devices	1. The communication protocol is different between two modules, for instance: data rate and checkout.
	2. The frequency or RF data rate is different between two communicated modules.
	3. They are not the same kind products.
	4. The connection between module and terminal is wrong.
	5. The module is wrong.
	6. The setting of EN is wrong.

## RF1276D27 500mW LoRa Transceiver module V2.0

	7. The communication distance exceeds the range, or the connection of antenna is bad.
Short communication distance	1. The supply voltage exceeds range
	2. The ripple of power is too big.
	3. The connection of antenna is bad or it is a wrong kind of antenna
	4. Antenna is too close to the surface of metal or the ground
	5. Receiving circumstance is very bad, for instance buildings and strong interference.
	6. There is interference of the same frequency
Receive wrong data	1. Wrong setting of COM, for example, Baud rate is wrong
	2. The connection of UART is wrong.
	3. The cable to the UART is too long.

<p>APPCON WIRELESS TECHNOLOGIES CO.,LTD</p> <p>Add: 28#, Longjin road,Xili zone, Nanshan District Shenzhen P.R.C(518043)</p> <p>TEL: +86-185 0309 2598</p> <p>FAX: +86-755-83405160</p> <p>Email: <a href="mailto:sales@appconwireless.com">sales@appconwireless.com</a></p> <p>Web: <a href="http://www.appconwireless.com">http://www.appconwireless.com</a></p>	<p>AppconWireless technologies reserves the right to make corrections, modifications, improvements and other changes to its products and services at any time and to discontinue any product or service without notice. Customers are expected to visit websites for getting newest product information before placing orders.</p> <p>These products are not designed for use in life support appliances, devices or other products where malfunction of these products might result in personal injury. Customers using these products in such applications do so at their own risk and agree to fully indemnify AppconWireless technologies for any damages resulting from improper use</p>
------------------------------------------------------------------------------------------------------------------------------------------------------------------------------------------------------------------------------------------------------------------------------------------------------------------------------------------------------------------------	-----------------------------------------------------------------------------------------------------------------------------------------------------------------------------------------------------------------------------------------------------------------------------------------------------------------------------------------------------------------------------------------------------------------------------------------------------------------------------------------------------------------------------------------------------------------------------------------------------------------------------------------------------------------------------------------------